

CHILDREN'S ELECTRONIC TOY CAR

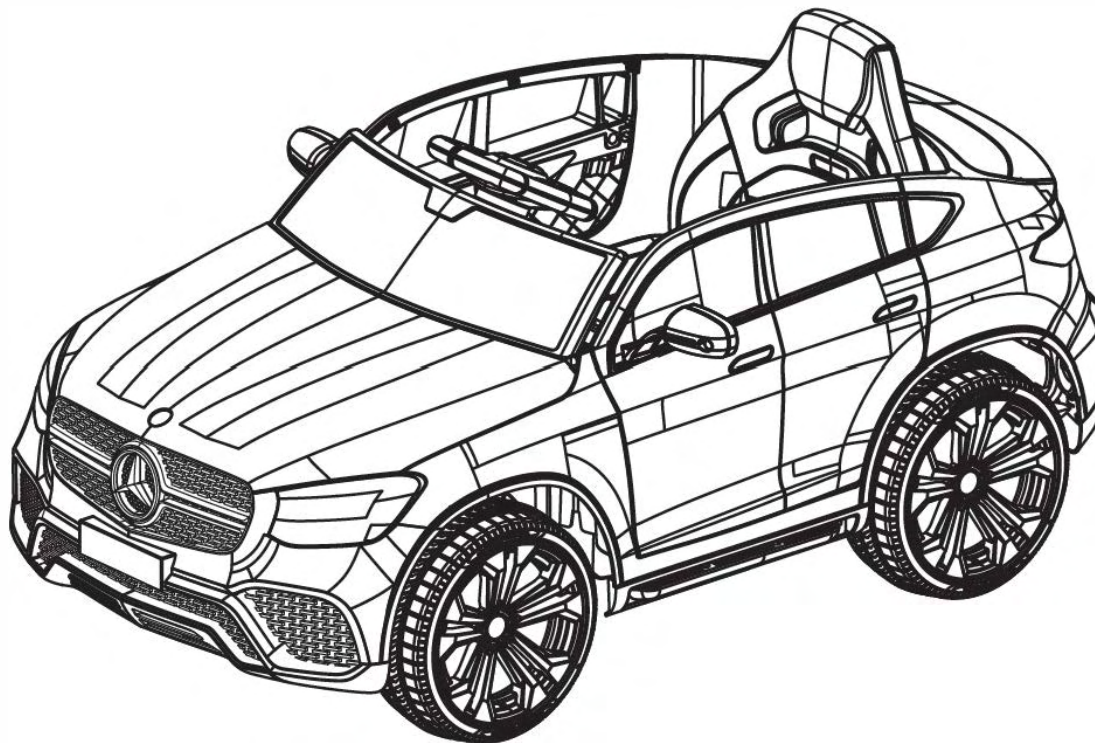

Important	Warning!
Age: 3+Years Maximum user weight : 25 Kg	<ol style="list-style-type: none">1. Not Suitable for children under 36 months. Choking hazard due to small parts2. For family and domestic use only3. Not to be used in traffic4. Adult assembly required5.Warning! Protective equipment should be worn6. This toy has no brake7. This toy is unsuitable for children under 3 years due to its maximum speed.8. This toy contains batteries that are non-replaceable9. It has the potential hazards of using the ride-on electric toys in areas other than private grounds

OWNER'S MANUAL

Read and understand this entire manual before using!

Please keep this manual for future reference as it contains important information. Before first time use, charge the battery for at least 8-12 hours, no more than 20 hours.

Table of Contents

1. About Your New Vehicle	Page 2
2. Parts List	Page 3
3. Parts Diagram	Page 4
4. Assembly Steps	Page 5-7
5. How To Operate Your Vehicle	Page 8-12
6. Charging The Vehicle	Page 13
7. Troubleshooting Guide	Page 14
8. Maintaining Your Vehicle	Page 15
9. Disposal Of Battery	Page 16

About Your New Vehicle

Thank you for purchasing our products, we want your child to enjoy this product for years to come. Keep these points in mind as you read this guide:











Suitable age:	3+ years	Battery:	DC 6V 4.5 AH*1 /12V4.5AH*1
Load Capacity:	Under 25 Kg	Product size:	105 X 68 X 50 cm
Motor:	6V390*1(Drive)/ 12V390*2(Drive)	Speed:	3-5km/h
Charger:	Input: 100-240V, 50-60Hz	Charging time:	8-12 hours, at most 20 hours
	Output: 6V-8V /12V-15V	Fuse:	4A--8A,Self-resetting

WARNING!

FOR THE SAFETY OF YOUR CHILD, PLEASE READ ALL WARNINGS AND ASSEMBLY/USE INSTRUCTIONS. KEEP THIS GUIDE FOR FUTURE REFERENCE.

- **ADULT ASSEMBLY REQUIRED.** The product contains small parts, which are for adult assembly only. Keep small children away when assembling.
- Always remove protective material and poly bags and dispose before assembly.

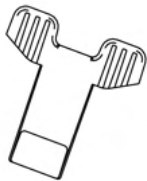
Parts List

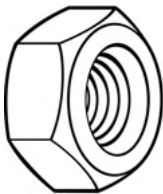
PART NO	PART NAME	PICTURE	Qty (pcs)	REMARKS	PART NO	PART NAME	PICTURE	Qty (pcs)	REMARKS
1	Vehicle body		1		2	Wind-shield		1	
3	Seat		1		4	Gear box		1 or 2	Installed on the vehicle body.
5	String wheel		1		6	Wheel		4	
7	Wheel shaft cover		4		8	Rearview mirror		1	Left & Right
9	Manual		1		10	Charger		1	
11	Spanner		2		12	Remote control		1	
13	M10 washer		6 or 7	Placed on the rear and front axle	14	M8 Nut			Placed on the rear and front axle

Parts Diagram



NOTE: Some Parts Shown are assembled on both sides of vehicle

Tools Required



Screwdriver(not included)



Pliers(not included)



Hammer(not included)

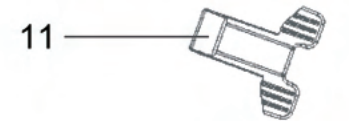

Spanner(included)

Assembly Steps

- Your new vehicle requires adult assembly. Please set aside at least 40 minutes for assembly. Children can be harmed by small parts, sharp edges and sharp points in the vehicle's unassembled state. Care should be taken in unpacking and assembly of the vehicle. Children should not handle parts, or help in assembly of the vehicle.
- Please identify all parts before assembly and save all packaging material until assembly is complete to ensure that no parts are discarded.
- Assembly tool for need: screwdriver(not included), pliers(not included), hammer(not included),Spanner(included).

1. Installation of rear wheels



- Install drive motor on the rear axle
- Load a wheel on the rear axle
- Load a 10# gasket on the rear axle
- Tighten 8 nuts with a plastic wrench
- Add a plastic core cover

Note: Double drive left and right wheel installation method is the same; single drive the other side wheel installation reference front wheel installation;

2. Install the front wheel.

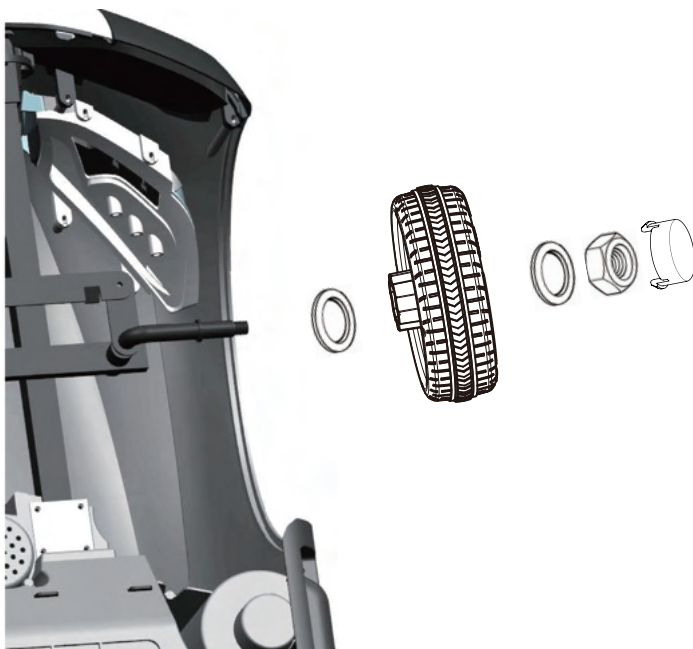

- Load a 10# gasket on the rear axle
- Add a front wheel
- Load another M10 gasket
- Tighten 8 nuts with a plastic wrench
- Add a plastic core cover

Note: both sides of the front wheel installation method is the same

Assembly Steps

3. Connect the power supply

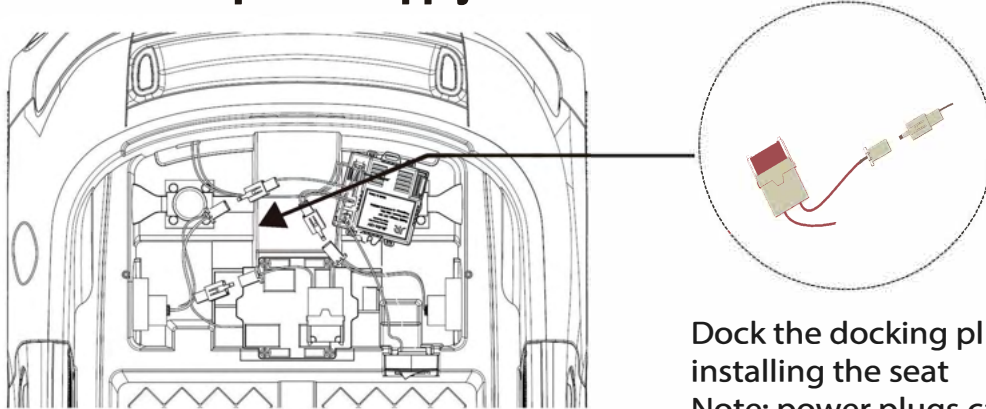

Dock the docking plug before installing the seat
Note: power plugs cannot be operated in reverse



Battery Safety Warning

Different types of batteries or old and new batteries can not be combined.
Non-rechargeable batteries can not be recharged.
Batteries can only be recharged under adult supervision.
Rechargeable batteries should be removed from vehicle before charging.

The battery should be placed in the correct polarity.
Exhaust batteries should be removed from vehicle.
Power terminals must not short-circuit.
Dry batteries are not available.

5. Install the seat

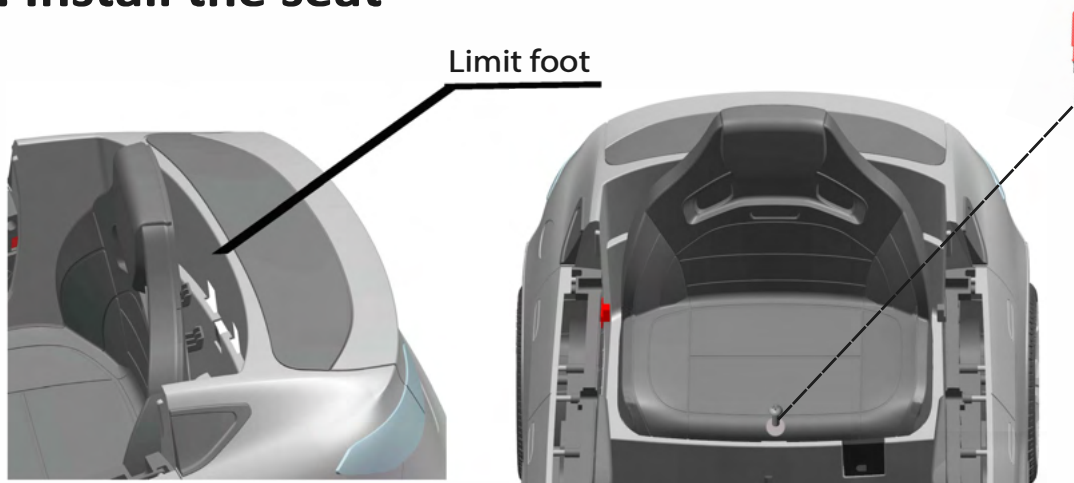

- Insert the limit foot of the back end of the seat on the car body;
- Place the seat on the car body and fix it with 1pc **M4X20mm** screws

Assembly Steps

6. Install the windshield



- Press the windshield into the body until installed.

7. Install the steering wheel

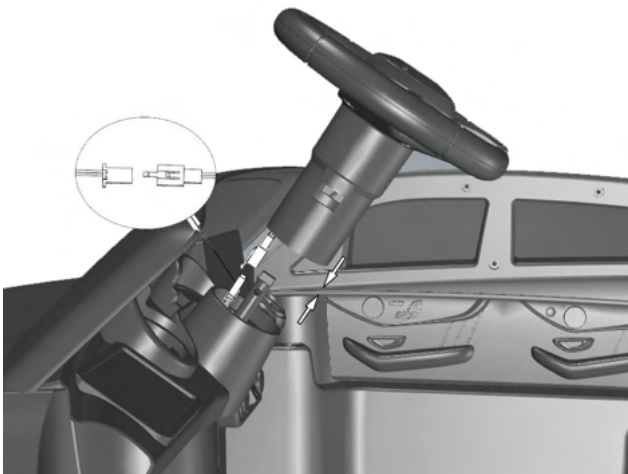

- Butt connection plug[as shown].
- Distinguish the front and rear of the steering wheel and clamp the steering wheel on the dashboard.

【One-button installation】

8. Install the rearview mirror

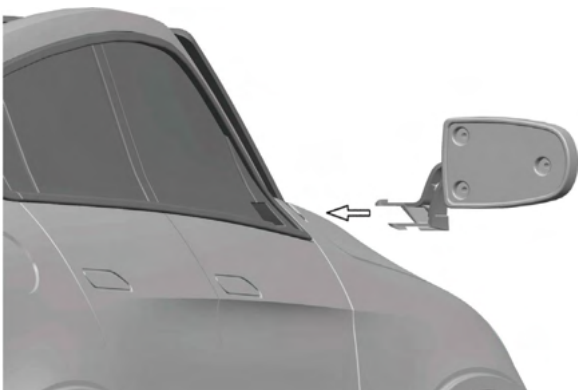

- The left and right sides of the reflecting mirror are respectively inserted on the vehicle body.

How To Operate Your Vehicle

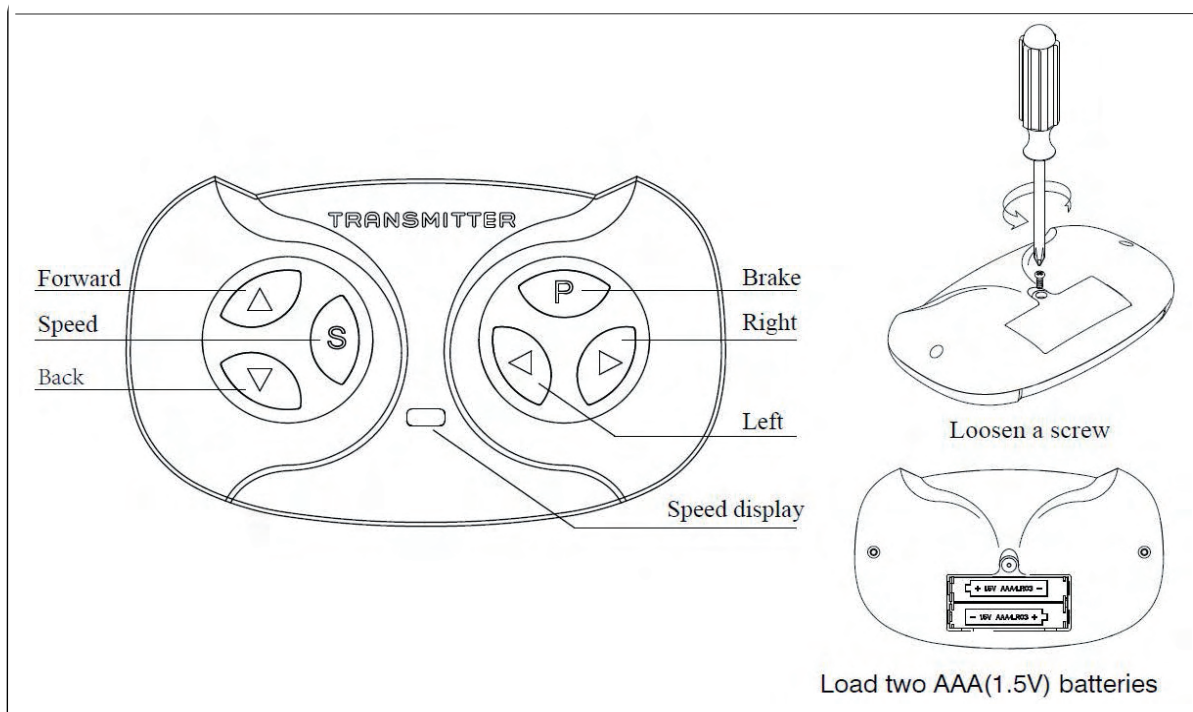

Step 1: open the battery cover on the back of the remote control and load into 2pcs AAA(1.5V) batteries; (dry batteries are not available in this product)

Step 2: turn off the main power switch on the car;

Step 3: hold down **Forward** and **Back** keys at the same time, (note that hold down at the same time) when the **Speed display** flashing, the main power switch on the car, the **Speed display** red light to stop flashing, code success;

Key description: **Speed** key for speed regulation, each time change a speed, **Speed** key on a red light for low speed, two red lights for medium speed, three red lights for high speed;

- Press button **Forward** and the car moves forward;
- Touch and press **Back** , the car back;
- Press button **Speed display** to adjust the speed of the car.
- Touch and press **Left** key . The car turns to the left.
- Touch and press **Right** and the car turns to the right;
- Brake** for the brake key, touch the car to maintain the brake state, red indicator all flashing, and then touch the brake state contact;

Special description: If the product has the function of code-free, the remote control installed on tow AAA (1.5v) batteries, you can use the remote control to operate the product; vice versa, according to the code operation instructions to code;

This product may have remote control priority (depending on product configuration): When the remote control is operated, the pedal switch of the product is invalid; when the remote control operation is stopped, the pedal switch of the product can be used.

How To Operate Your Vehicle

WARNING!

- To reduce the risk of injury, adult supervision is required. Never use in roadways, near motor vehicles, on or near steep inclines or steps, swimming pools or other bodies of water; always wear shoes, and never allow more than one rider.
- The toy should be used with caution since skill is required to avoid falls or collisions causing injury to the user or third parties.
- The kinds of surfaces which are appropriate for safe use of the toy.
- Only use the battery specified by the manufacturer,
- Only use the charger specified by the manufacturer.
- Suitable for age 3+ years Maximum user weight is 25 kgs. •Not to be used in traffic .

Must confirm before using that following work which is already finished:

- **Important!** Before using the vehicle for first time, the battery needs to be charged for 8 to 12 hours, no more than 20 hours. Only an adult can charge or recharge the battery.
- Finishing the complete car to assemble according to the steps that the manual described. The plug-in package of storage battery has already been inserted well, the power has already been put through.
- All places to need the screw guarantee the screw has already been locked.

Rules for Safe Riding

READ THESE RULES ALOUD TO YOUR CHILD AND THEIR PLAYMATES AND MAKE SURE THEY UNDERSTAND THEM!

- This toy is no break. Always wear a helmet and protective clothing when riding.
- Direct Adult Supervision Required.
- Keep Children within Safe Riding Areas.
- Never driving in roadway, near motor vehicles, on lawn space, on near steep inclines or steps, swimming pools or other bodies of water.
- Use the toy only on flat surfaces. such as inside your house, garden or playground.
- Never use in the dark. A child could encounter unexpected obstacles and have an accident. Operate the vehicle only in the daytime or a well-lit area.
- It is not recommended to drive the vehicle on wet surfaces or on lopes of greater than 15 degrees.
- Do not use this vehicle outdoors when it is raining or snowing.
- Make sure you come to a complete stop before changing directions from forward to back.
- Please follow the correct weight and age limits allowed to drive this vehicle.
- It is prohibited to change the circuit or add other electric parts
- Inspect wires and connections of the vehicle periodically.
- In order to avoid accidents, please ensure the vehicle is safe before riding.
- Do not let any child touch the wheels or be near them when the car is moving .
- This vehicle has adjustable play seat belts. please instruct children how to tie the safety belt before using, guarantee the security.

How To Operate Your Vehicle

Use Operation(Ensure the power switch has been turned on)



Light Swith
Power switch

IMPORTANT!

Always stop vehicle when changing the speed or direction to avoid damage the gear box and motor.

MP3 Player

Foot pedel

Forward/Stop/Backward switch

(1) Turn on the general power switch first.

(2) Forward

Press the "Forward and Reverse switch" to the "Forward" position.

Press the pedal.

The vehicle drives forward.

(3) Stop

Remove foot from the accelerator pedal to stop the car.

(4) Reverse

Press the "Forward and Reverse switch" to the "Reverse" position.

Press the pedal.

The vehicle drives backward.

How To Operate Your Vehicle

(5) How to operate MP3 player

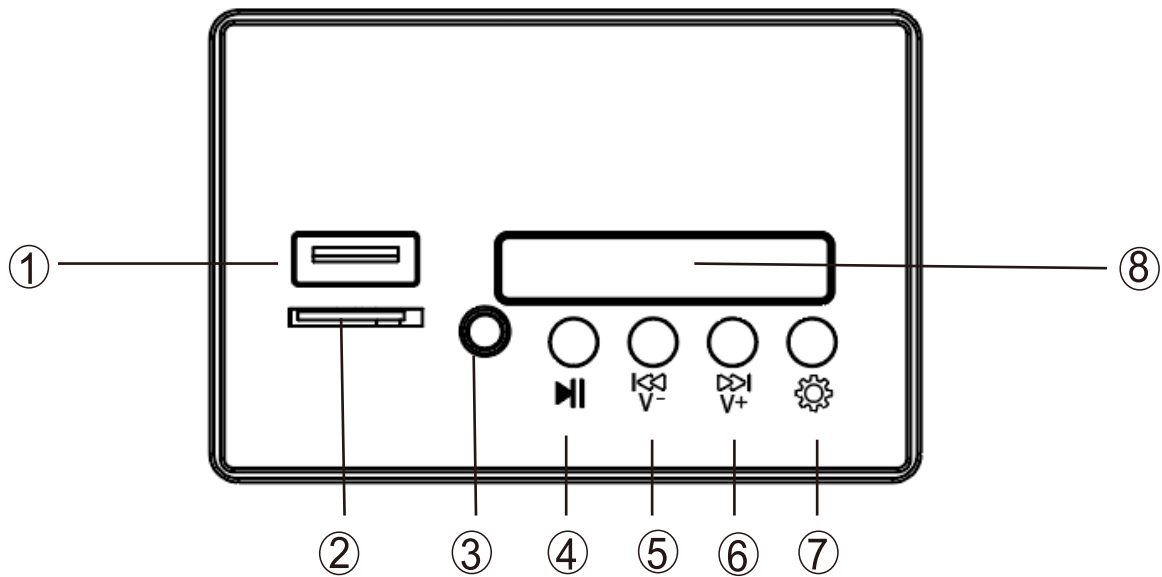

- ① USB interface:insert USB terminal,connect audio source,can paly audio;
- ② TF card jack:insert TF card,can play audio;
- ③ AUX interface:through the data line can be connected to other devices and play audio;
- ④ Pause button:touch this button,can pause the audio playing;
- ⑤ Volume-/music previous:short press,can play previous music,
long press can reduce the volume;
- ⑥ Volume+/music next:short press,can play next music,
long press can increase the volume;
- ⑦ Funcation Button:After connected a USB drive or TF card,
Press this button to choose which device to play the source
- ⑧ Voltage display:the value on the display can be used to determine whether the battery
need charge or not.(6V battery:charge below 6.2V;
12V battery:charge below 12.3V)

(6)How to use the steering wheel button



Horn and Music button

How To Operate Your Vehicle

Circuit diagram

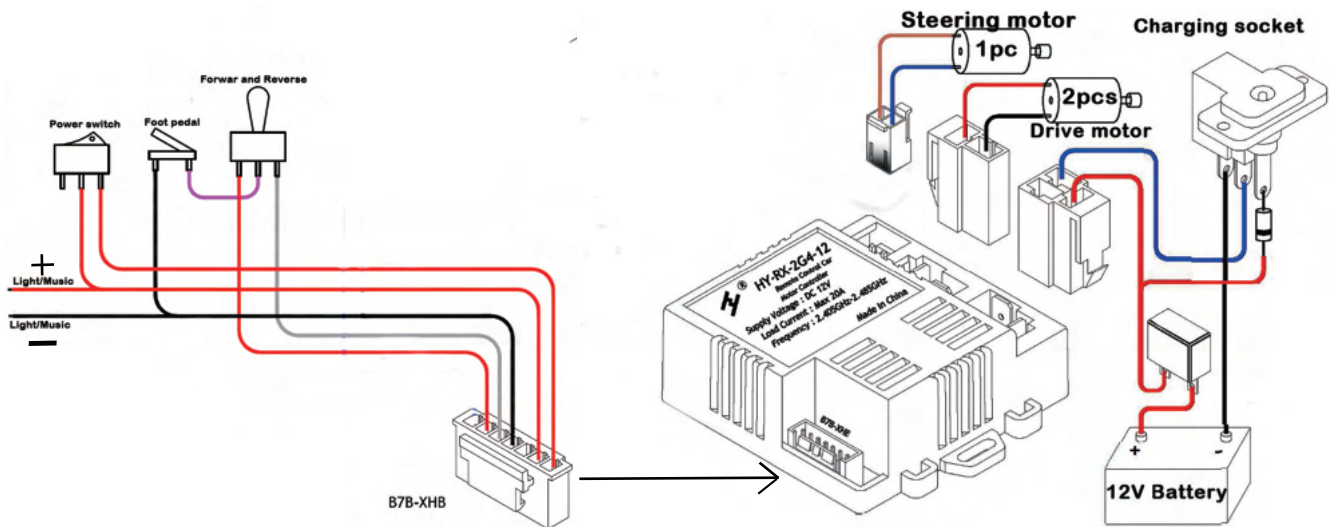

Charging Your Vehicle

ONLY AN ADULT CAN CHARGE AND RECHARGE THE BATTERY!

WARNING!

• **PREVENT FIRE AND ELECTRIC SHOCK:**

- Use the only rechargeable battery and charger supplied with your vehicle. NEVER substitute the battery or the charger with another brand. Using another battery or charger may cause a fire or explosion.
 - Do not use the battery or charger for any other product. Overheating, fire or explosion could occur.
 - NEVER modify the electric circuit system. Tampering with the electric system may cause a shock, fire or explosion or may permanently damage the system.
 - Do not allow direct contact between battery terminals. Fire or explosion can occur.
 - Do not allow any type of liquid on the battery or its components.
 - Explosive gasses are created during charging. Do not charge near heat or flammable materials. Charge the battery in a well-ventilated area ONLY.
 - NEVER pick up the battery by the wires or charger. Damage can occur to the battery and may cause a fire. Pick up the battery by the case ONLY.
 - Charge the battery in a dry area ONLY.
- Remove high-lighted section. **Wash hands after handling.**
- Do not open the battery. Battery contains lead acid and other materials that are toxic and corrosive.

Charging Your Vehicle

WARNING!

• **PREVENT FIRE AND ELECTRIC SHOCK:**

- Do not open the charger. Exposed wiring and circuitry inside case may cause electric shock. Only adults may handle or charge the battery. NEVER allow child to handle or charge the battery. Battery is heavy and contains lead acid (electrolyte).
- Do not drop the battery. Permanent damage to the battery could occur or cause serious injury.
- Before charging the battery, check for wear or damage to the battery, charger, its supply cord and the connectors. DO NOT charge the battery if any damage to parts has occurred.
- Do not allow the battery to drain completely. Recharge the battery after each use or once a month if not used regularly.
- Do not charge battery upside down.
- Always secure the battery with the bracket. Battery can fall out and injure a child if vehicle tips over.
- A recommendation for adult supervision of young children.
- The toy should be used with caution since skill is required to avoid falls or collisions causing injury to the user or third parties.

- The charging input socket is **BELOW THE SEAT**.
- The **POWER SWITCH** must be turned in **OFF** position when charging.
- Before the first use, you should charge the battery for 8-12 hours. Do not recharge the battery for more than 20 hours to avoid overheating the charger.
- When the vehicle begins to run slowly, recharge the battery.
- After each use or once a month minimum recharge time as 8 to 12 hours, no more than 20 hours.



WARNING!

**This product with CHARGING PROTECTION:
When charging, all the functions will be cut off!**

1. Find The charging input socket below the seat;
2. Plug the charger port into the input socket;
3. Plug the charger plug into a wall outlet. The battery will begin

Troubleshooting Guide

■ PROBLEM: The vehicle does not run

PROBLEM CAUSE: The battery may low on power.

After each use, or once a month minimum, charge the battery for 8-12 hours. Do not leave the battery on the charger for more than 20 hours.

POSSIBLE CAUSE: Thermal fuse has tripped.

The vehicle is equipped with a self-resetting fuse. When the vehicle is overloaded or operated incorrectly; the self-resetting fuse will be cut off for 5-20 seconds before becoming operational again. The self-resetting fuse is under the seat (Refer to the picture.)

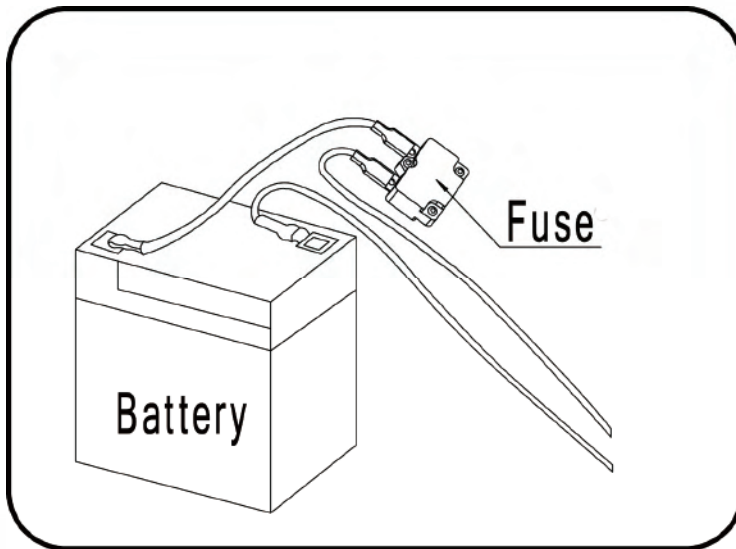

To avoid the fuse cut off the power, follow these guidelines:

DO NOT overload the vehicle, Maximum weight allowed : 25kg

DO NOT tow anything behind the vehicle.

DO NOT drive up steep slopes.

DO NOT drive into fixed objects, which may cause the wheels to spin, causing the motor to overheat.

DO NOT drive in very hot weather, components may overheat.

DO NOT tamper with the electric system, Doing so may create a short circuit, causing the fuse to trip.

POSSIBLE CAUSE: Wheel nuts are loose.

If the nuts are not tight, the wheels will not engage the forward gears. Tighten the nut with the nut wrench.

POSSIBLE CAUSE: Battery connector or wires are loose.

Make Sure the battery connectors are firmly plugged in to each other.

POSSIBLE CAUSE: Battery is dead.

Have you properly maintained the battery according to the directions? Is the battery old? Your battery may need to be replaced.

POSSIBLE CAUSE: Electric system is damaged.

Water may have corroded the system, or loose dirt, gravel or sand might have jammed the switch.

POSSIBLE CAUSE: Motor is damaged.

The motor needs professional repair.

■ PROBLEM: The battery will not recharge.

POSSIBLE CAUSE: Battery connector or adapter connector is loose.

Make sure the battery connector and adapter connector are firmly plugged together.

POSSIBLE CAUSE: Charger is not plugged in.

Make sure the charger is plugged into the wall outlet and the power flow to the outlet is on.

POSSIBLE CAUSE: Charger is not working.

Is the charger warm while charging? If not, the charger may be broken and may need to be replaced.

Troubleshooting Guide

■ **PROBLEM: The vehicle does not run very long.**

POSSIBLE CAUSE: Battery may be undercharged.

You may not be charging the battery long enough. After each use, or once a month minimum, charge the battery for 8 to 12 hours. Do not leave the battery on the charger for more than 20 hours.

POSSIBLE CAUSE: Battery is old.

The battery will eventually lose the ability to hold a charge. Depending on the amount of use, and varying conditions, the battery should operate for one to three years. Replace the battery with a new One.

■ **PROBLEM: Battery buzzes or gurgles when charging.**

This is normal and not a cause for concern. It may also be silent when charging, which is also normal.

■ **PROBLEM: Charger feels warm when recharging battery.**

This is normal and not a cause for concern.

Maintaining Your Vehicle

- It is parents' responsibility to check main parts of the toy before using, Must regularly examine for potential hazard, such as the battery, charge, cable or cord, plug, screws are fastening enclosure of other parts and that in the event of such damage, the toy must not be until that damage had been properly removed.
- Make sure the plastic parts of the vehicle are not cracked or broken.
- Occasionally use a lightweight oil to lubricate moving parts such as wheels.
- Park the vehicle indoors or cover it with a tarp to protect it from wet weather.
- Keep the vehicle away from sources of heat, such as stoves and heaters. Plastic parts may melt.
- Recharge the battery after each use. Only an adult can handle the battery. Recharge the battery at least once a month when the vehicle Raider is not being used.
- Do not wash the vehicle with a hose. Do not wash the vehicle with soap and water. Do not drive the vehicle in rainy or snowy weather. Water will damage the motor, electric system and battery.
- Clean the vehicle with a soft, dry cloth. To restore shine to plastic parts, use a non-wax furniture polish. Do not use car wax. Do not use abrasive cleaners.
- Do not drive the vehicle in loose dirt, sand or fine gravel which could damage moving parts, motors or the electric system.
- When not using, all the electrical source should be turn off. Turn off the power switch and disconnect the battery connection.

Disposal Of Battery

Disposal Of Battery



- Your sealed lead-acid battery must be recycled or disposed of in an environmentally sound manner.
- Do not dispose of your lead-acid battery in a fire. The battery may explode or leak.
- Do not dispose of a lead-acid battery in your regular, household trash. The incineration, land filling or mixing of sealed lead-acid batteries with household trash is prohibited by law.
- Return an exhausted battery to your local approved lead-acid battery recycle, such as a local seller of automotive batteries.
- Contact your local waste management officials for other information regarding the environmentally sound recycling and disposal of lead-acid batteries.
- The battery must be charged only by adult .Please charge the product before using!
- The toy should not be connected to excessive powers (more than the quantity specified herein), and it should not be operated during charging process.
- Any rechargeable battery must only be charged under adult's supervision.
- Battery charger shall regularly check the wires, plugs, casing and other parts for damage and found damage should stop using and restored.
- Open the battery cover on the remote control, and put two pieces of batteries, paying attention to batteries polarity. Replace the battery cover and lock with screws (please replace the battery according to the above steps and should be done by adult) .
- All batteries should be inserted with the correct polarity.
- Non-rechargeable battery should not be charged, please remove any running-off battery from the toy.
- Do not use old and new batteries together, or mix different types of batteries.
- The battery charger used with the toy are to be regularly examined for damage to the cord, plug, enclosure and other parts, and in the event of such damage, they must not be used until that damage had been repaired.