



- **12VTRTR**
- **Suitable for 3-8 YEARS**
- **Maximum user weight: 30kg**
- **Adult assembly required**



WARNING

Must be assembled by an adult.

OWNER'S MANUAL

Read and understand this entire manual before using!

Please keep this manual for future reference as it contains important information.

Before the first use, you should charge the battery for at least 8 hours. Do not recharge the battery for more than 12 hours to avoid overheating the charger.

Table of Contents

1. About Your New Vehicle
2. Parts List
3. Parts Diagram
4. Assembly Steps
5. How to Operate Your Vehicle
6. Charging The Vehicle
7. Troubleshooting Guide
8. Maintaining Your Vehicle
9. Disposal Of Battery

About Your Vehicle

Thank you for purchasing our products, we want your child to enjoy this product for years to come.

Keep these points in mind as you read this guide:

Suitable age:	3-8 years	Battery:	DC 12V4.5AH 、 12V7AH
Load Capacity:	Under 30Kg	Size of car:	1040*585*380mm
Material:	PP+metal	Use time:	Over 40 minutes per each charge
Speed:	Forward speed 3.5 km/h Reverse speed 3 km/h	Optimum Temperature:	Between 5-40°C Avoid to use under burning sun
Charger:	Input: Shown on the charger	Charging time:	No more than 12 hours
	Output: DC12V	Fuse:	F10A, Self-resetting
	Current: DC0.5A、 1A	Operating life:	12 months to 18 months

WARNING!











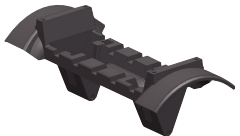
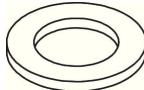

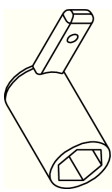
FOR THE SAFETY OF YOUR CHILD, PLEASE READ ALL WARNINGS AND ASSEMBLY/USE INSTRUCTIONS. KEEP THIS GUIDE FOR FUTURE REFERENCE.

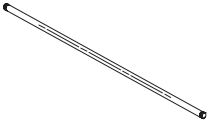
- ADULT ASSEMBLY REQUIRED. The product contains small parts, which are for adult assembly only. Keep small children away when assembling.
- Always remove protective material and poly bags and dispose before assembly.

Parts List

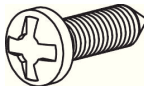
PART NO.	PART NAME	PICTURE	Q'TY (pcs)	REMARKS	PART NO.	PART NAME	PICTURE	Q'TY (pcs)	REMARKS
1	Vehicle body		1		2	Seat		1	
3	Steering Wheel		1		4	Armrest		2	
5	Chimney		1		6	Gear Box		2	
7	Rear Fender		2		8	fence 1		1	
9	Front Fender		2		10	fence 2		1	
11	Front Axle Seat		2		12	fence 3		1	
13	Front Axle		2		14	Bucket		1	

Parts List

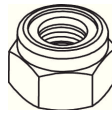
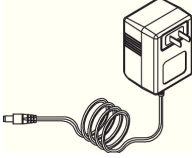
Assem bly package									
PART NO.	PART NAME	PICTURE	Q'TY (pcs)	REMARKS	PART NO.	PART NAME	PICTURE	Q'TY (pcs)	REMARKS
15	Fixing Seat of Bucket Tires		1		16	Ø12 washer		8	
17	Bucket Latch		1		18	wrenches		2	
19	Bucket Axle Sleeve		2		20	Rear Axle		1	
21	Front Hubcap		4		22	Bucket shaft		1	
23	Front Wheel		4		24	ST4.0*12		16	
25	Rear Hubcap		2		26	Control Lever		1	
27	Rear Wheel		2		28	M10 Nut		8	
29	Charger		1						

Parts Diagram

1	Vehicle body	2	Seat
3	Steering Wheel	4	Armrest
5	Chimney	6	Gear Box
7	Rear Fender	8	fence 1
9	Front Fender	10	fence 2
11	Front Axle Seat	12	fence 3
13	Front Axle	14	Bucket
15	Fixing Seat of Bucket Tires	16	Ø12 washer
17	Bucket Latch	18	wrenches
19	Bucket Axle Sleeve	20	Rear Axle
21	Front Hubcap	22	Bucket shaft
23	Front Wheel	24	ST4.0×12
25	Rear Hubcap	26	Control Lever
27	Rear Wheel	28	M10 Nut
29	Charger		

NOTE: Some Parts Shown are assembled on both sides of vehicle

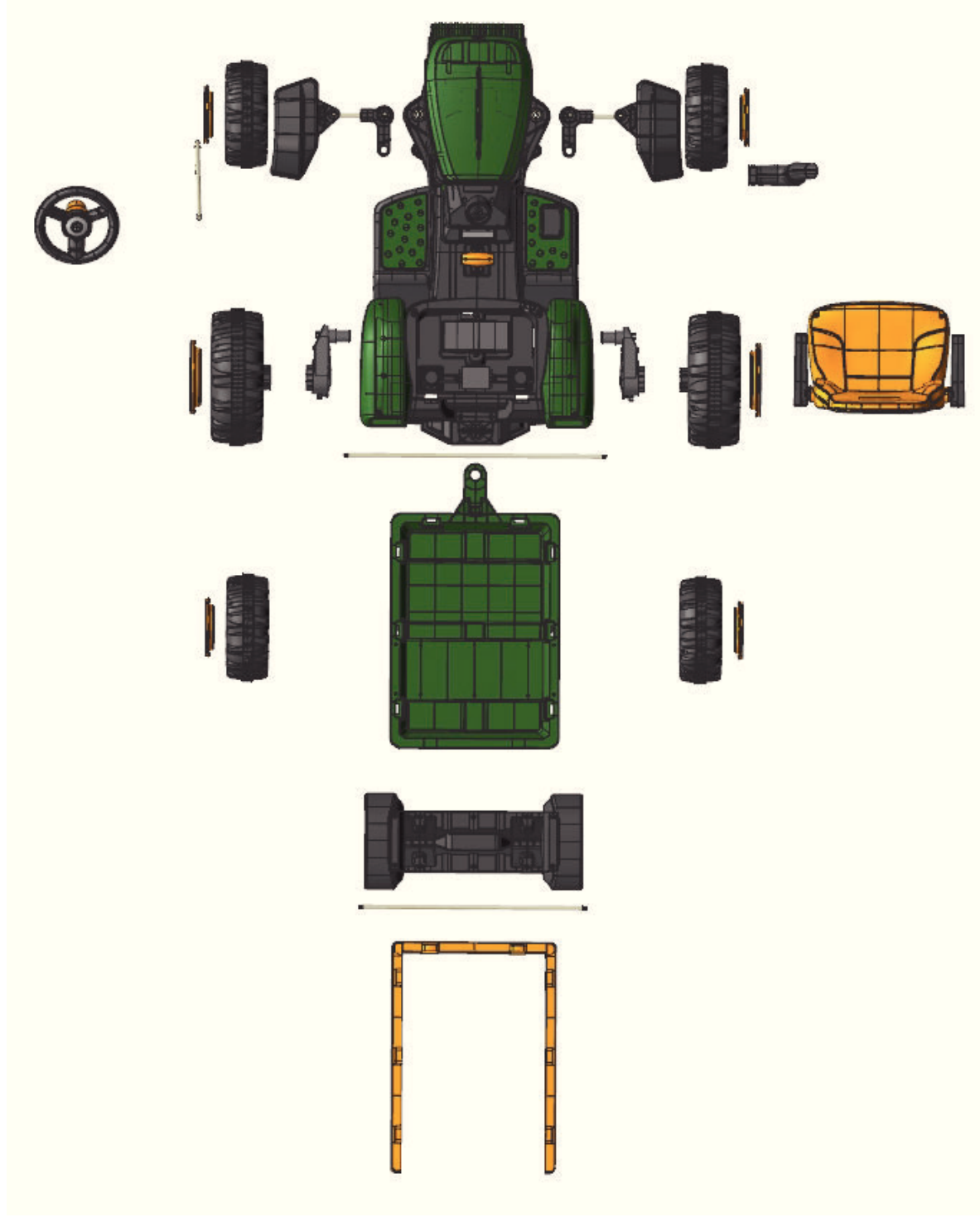

Assembly Steps

- Your new vehicle requires adult assembly. Please set aside at least 40 minutes for assembly. Children can be harmed by small parts, sharp edges and sharp points in the vehicle's unassembled state. Care should be taken in unpacking and assembly of the vehicle. Children should not handle parts, or help in assembly of the vehicle.
 - Please identify all parts before assembly and save all packaging material until assembly is complete to ensure that no parts are discarded.
 - Assembly tool needed: screwdriver(not included) and wrenches(included)
- Don't use it in dangerous places such as streets, roads and landslides, and it must be used under the supervision of adults
 - Fasten your seat belt and make sure your baby is always seated, meanwhile, don't let the baby stand or do some dangerous actions while running

Assembly Steps

1、 Install front axle and fender

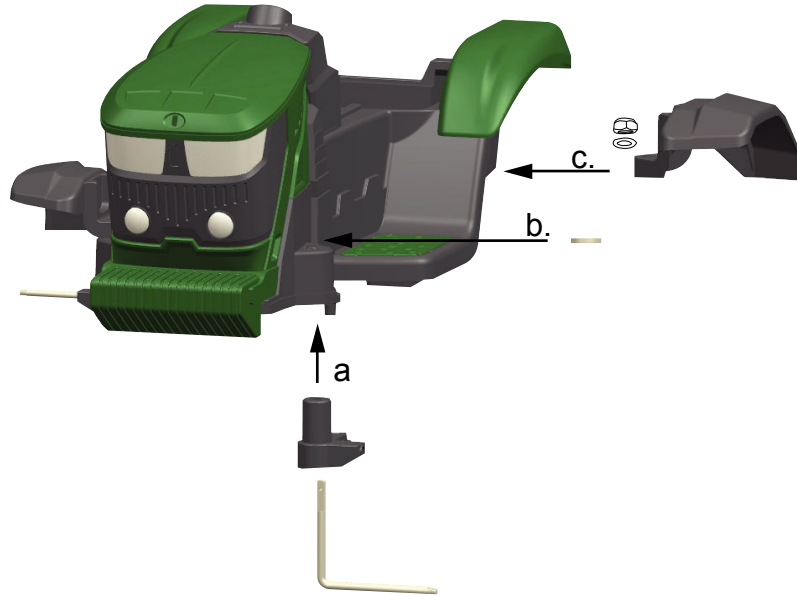

First, put the front axle seat, front axle and fender on the specific position, then put on the gasket and use pin to fix it.

2、 Install control lever, rear axle and gear box

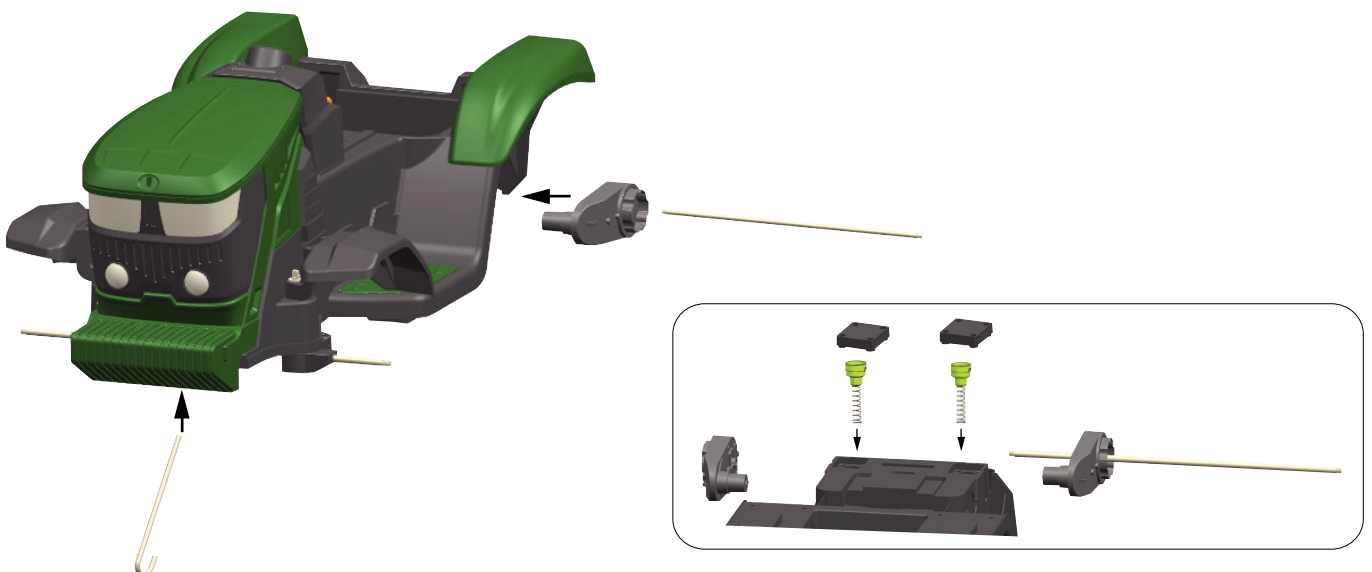

First, insert steering motor into the control lever. Then fix the rear axle on the vehicle body through the damping sleeve in turn. And fix the rear axle with pressing plate. Finally, fix the left and right drive motors on the rear axle and connect the plug-in with the car body plug-in.

Assembly Steps

3、 Install the front and back wheel

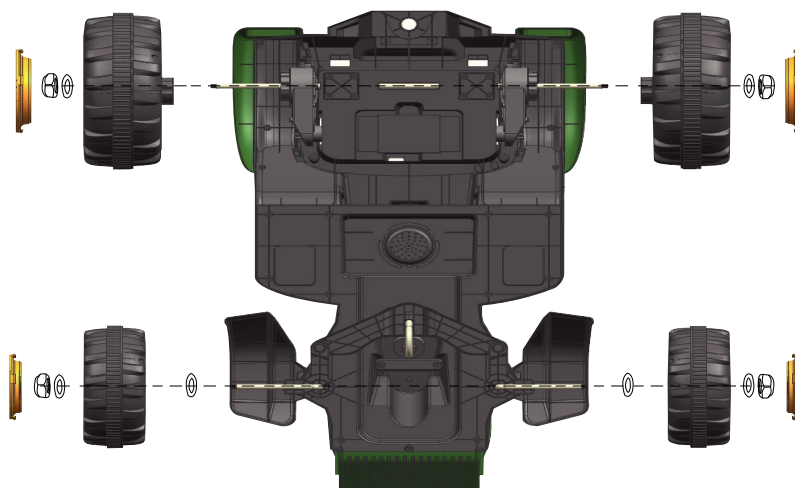

First, put the gasket and front wheel onto the front axle in turn, then put another gasket into it, lock it with M10 nut, and cover the front hubcap. Then put the rear wheel on the rear axle, and put in the gasket, lock it with M10 nut and cover the rear hubcap.

4、 Install the steering wheel



Connect the connector on the steering wheel with the body connector, and then sleeve the steering wheel into the fixed column of dash board. Align the screw with the hole to fix it.

Assembly Step

5、 Install the chimney



Align the chimney with the vehicle body slot and press it hard. It is installed in place when hearing the click sound.

6、 Install the seat

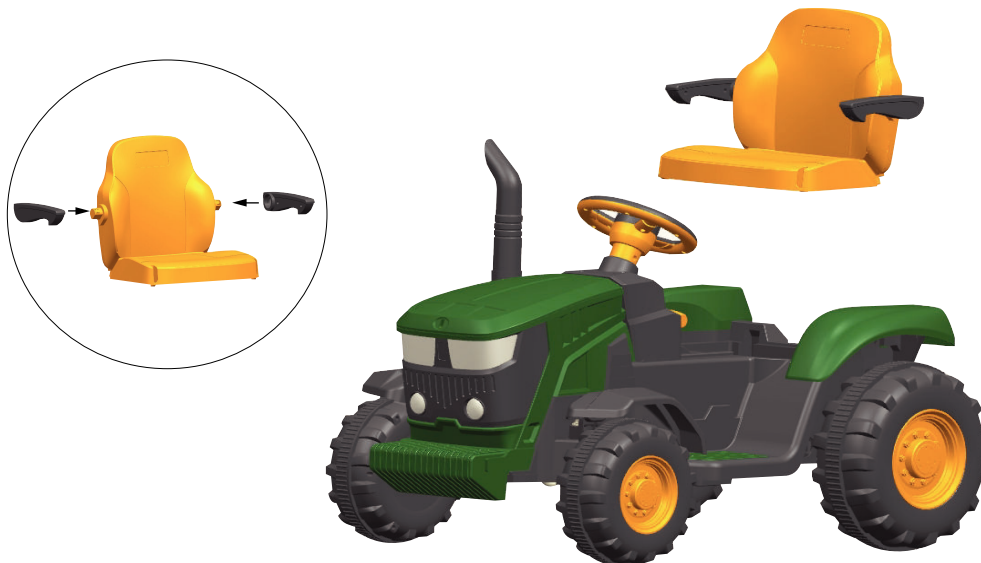

Install the armrest: First, distinguish the left and right armrest. Then install it on the seat.
Install the seat: Connect the positive pole of the power before installing the seat. Then place the seat in the designated position and align the hook with the body slot. Then screw the fixing holes on both sides of the seat clockwise. Insert the charger into the charging hole when charging. The whole vehicle doesn't have any function during charging.

Assembly Steps

7、 Install the bucket

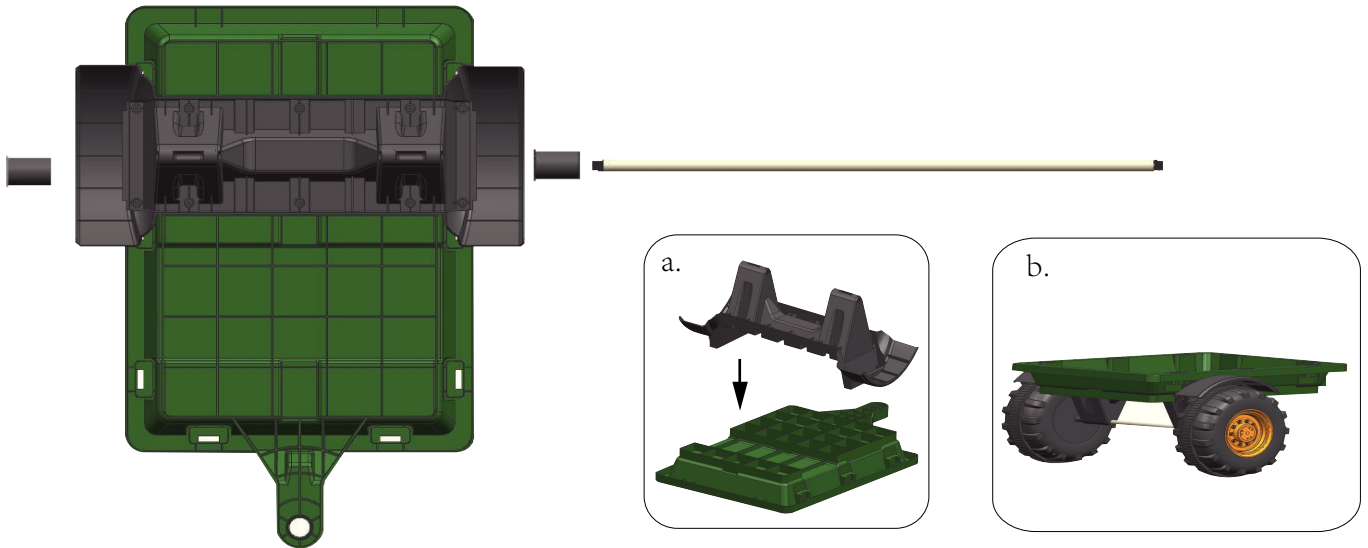

Place the fixing seat of the bucket tires on the baseboard of the bucket. Use ST4.0*12 self-tapping screws to lock it. Then fix the bucket shaft, bushing and front wheel on the bucket respectively, then insert the gasket, lock it with M10 nut and cover the front hubcap.

8、 Install the fence

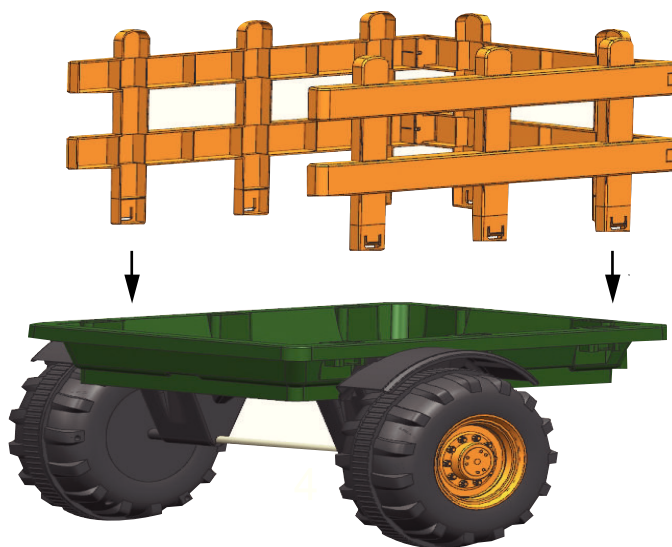

Combine the fence 1, 2 and 3 respectively, and then fix the combined fence on the bucket.

Assembly Steps

9、 Combination of the fence and the bucket

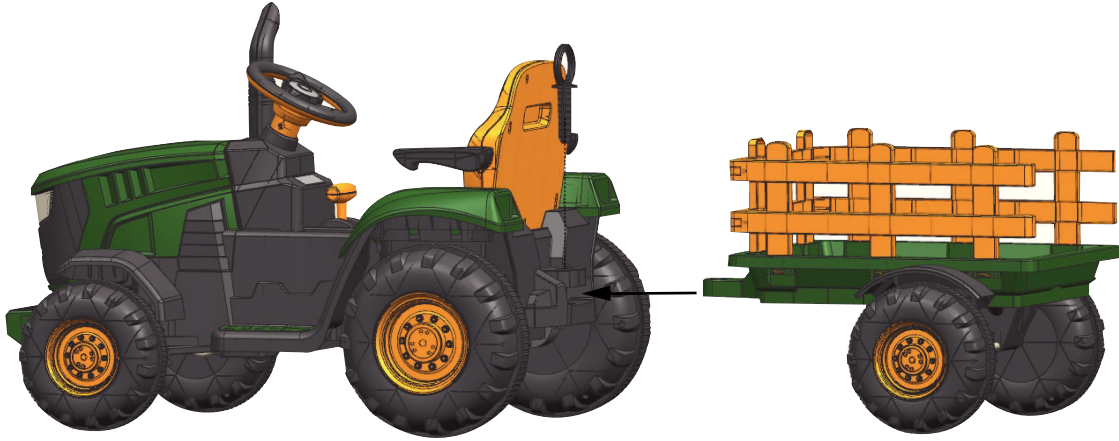

Insert the bucket into the back of the vehicle body. Then fix them together with the bucket latch.

10、 insert 2 AAA1.5 batteries into remote control

AAA1.5V



battery container cover

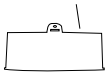

unscrewing the cover of battery container, putting in 2 AAA1.5V batteries correctly, then covering up.

please code matching from remote control to the car by following its process in the instruction.

How To Operate Your Vehicle

WARNING!

PREVENT INJURIES AND DEATHS:

NEVER LEAVE CHILD UNATTENDED. DIRECT ADULT SUPERVISION IS REQUIRE. Always keep child in view when child is in vehicle.

Never use in roadways, near cars, on or near steep inclines or steps, swimming pools or other bodies of water.

Always wear shoes.

Always sit on the seat.

Suitable for age 3-6 years; Maximum user weight is 30kgs.

Not to be used in traffic.

 **WARNING:** To reduce the risk of injury, adult supervision is required. Never use in roadways, near motor vehicles, on or near steep inclines or steps, swimming pools or other bodies of water, always wear shoer, and never allow more than one rider.

Must confirm before using that follwing work which is already finished:

Important! Before the first use, you should charge the battery for at least 8 hours. Do not recharge the battery for more than 12 hours to avoid overheating the charger.

Only an adult can recharge the battery.

Finishing the complete car to assemble according to the steps that the manual described. The plug-in package of storage battery has already been inserted well, the power has already ben put through.

All places to need the screw guarantee the screw has already been locked.

Rules for Safe Riding

READ THESE RULES ALOUD TO YOUR CHILD AND THEIR PLAYMATES AND MAKE SURE THEY UNDERSTAND THEM!

This toy has no brake. Always wear a helmet and protective clothing when riding.

Direct Adult Supervision Required.

Keep Children whitin Safe Riding Areas.

Never driving in roadways, near motor vehicles, on lawn sapce, onnear steep inclines or steps, swimming pools or other bodies of water.

Use the toy only on flat surfaces, such as inside your house, garden or playground.

Never use in the dark, a child could encounter unexpected obstacles and have an accident. Operate the vehicle only in the daytime or a well-lit area.

It is not recommended to drive the vehicle on wet surfaces or on lopes of greater than 15 degrees.

Do not use this vehicle outdoors when it is raining or snowing.

Make sure you come to a complete stop before changing directions from forward to back.

How To Operate Your Vehicle

Please follow the correct weight and age limits allowed to drive this vehicle.

It is prohibited to change the circuit or add other electric parts

Inspect wires and connections of the vehicle periodically.

In order to avoid accidents, please ensure the vehicle is safe before riding.

Do not let any child touch the wheels or be near them when the car is moving .

This vehicle has adjustable play seat belts. please instruct children how to tie the safety belt before using, guarantee the security.

Use Operation(Ensure the power switch has been turned on)



- (1) starting with engine sound when head and rear lights are lightening.
- (2) shifting forward back switch into forward position, pedalling on the accelerator, vehicle moves forward.
shifting forward back switch into back position, pedalling on the accelerator, vehicle moves back.
- (3) there are horn and music buttons on steering wheel.
the battery indicator shows voltage after starting.
please checking MP3 and USB accesses by according to instruction.
- (4) turn off and disconnecting batteries when it is not used, but doing re-charging every month.

Charging Your Vehicle

ONLY AN ADULT CAN CHARGE AND RECHARGE THE BATTERY!

- Non-rechargeable batteries are not to be recharged.
- Different type of batteries or new and used batteries are not to be mixed.
- Batteries are to be inserted with the correct polarity.
- Exhausted batteries are to be removed from the toy.
- The supply terminals are not to be short-circuited.
- Rechargeable batteries are only to be charged under adult supervision.
- Rechargeable batteries are to be removed from the toy before being charged.
- The transformers or battery charger used with the toy are to be regularly examined for damage to the cord, plug, enclosure and other parts, and in the event of such damage, they must not be used until that damage had been repaired.

WARNING!

• PREVENT FIRE AND ELECTRIC SHOCK:

- Use the only rechargeable battery and charger supplied with your vehicle. NEVER substitute the battery or the charger with another brand. Using another battery or charger may cause a fire or explosion.
- Do not use the battery or charger for any other product. Overheating, fire or explosion could occur.
- NEVER modify the electric circuit system. Tampering with the electric system may cause a shock, fire or explosion or may permanently damage the system.
- Do not allow direct contact between battery terminals. Fire or explosion can occur.
- Do not allow any type of liquid on the battery or its components.
- Explosive gasses are created during charging. Do not charge near heat or flammable materials. Charge the battery in a well-ventilated area ONLY.
- NEVER pick up the battery by the wires or charger. Damage can occur to the battery and may cause a fire. Pick up the battery by the case ONLY.
- Charge the battery in a dry area ONLY.
- Battery posts, terminals and related accessories contain lead and lead compounds, chemicals known to the State of California to cause cancer and reproductive harm. **Wash hands after handling.**
- Do not open the battery. Battery contains lead acid and other materials that are toxic and corrosive.
- Do not open the charger. Exposed wiring and circuitry inside case may cause electric shock. Only adults may handle or charge the battery. NEVER allow child to handle or charge the battery. Battery is heavy and contains lead acid (electrolyte).
- Do not drop the battery. Permanent damage to the battery could occur or cause serious injury.
- Before charging the battery, check for wear or damage to the battery, charger, its supply cord and the connectors. DO NOT charge the battery if any damage to parts has occurred.
- Do not allow the battery to drain completely. Recharge the battery after each use or once a month if not used regularly.
- Do not charge battery upside down.
- Always secure the battery with the bracket. Battery can fall out and injure a child if vehicle tips over.
- A recommendation for adult supervision of young children.
- The toy should be used with caution since skill is required to avoid falls or collisions causing injury to the user or third parties.

Charging Your Vehicle

- The charging input socket is **BELOW THE SEAT**.
- The **POWER SWITCH** must be turned in **OFF** position when charging.
- Before the first use, you should charge the battery for at least 8 hours. Do not recharge the battery for more than 12 hours to avoid overheating the charger.
- When the vehicle begins to run slowly, recharge the battery.
- After each use or once a month minimum recharge time as least 8 hours, not exceeding 12 hours.

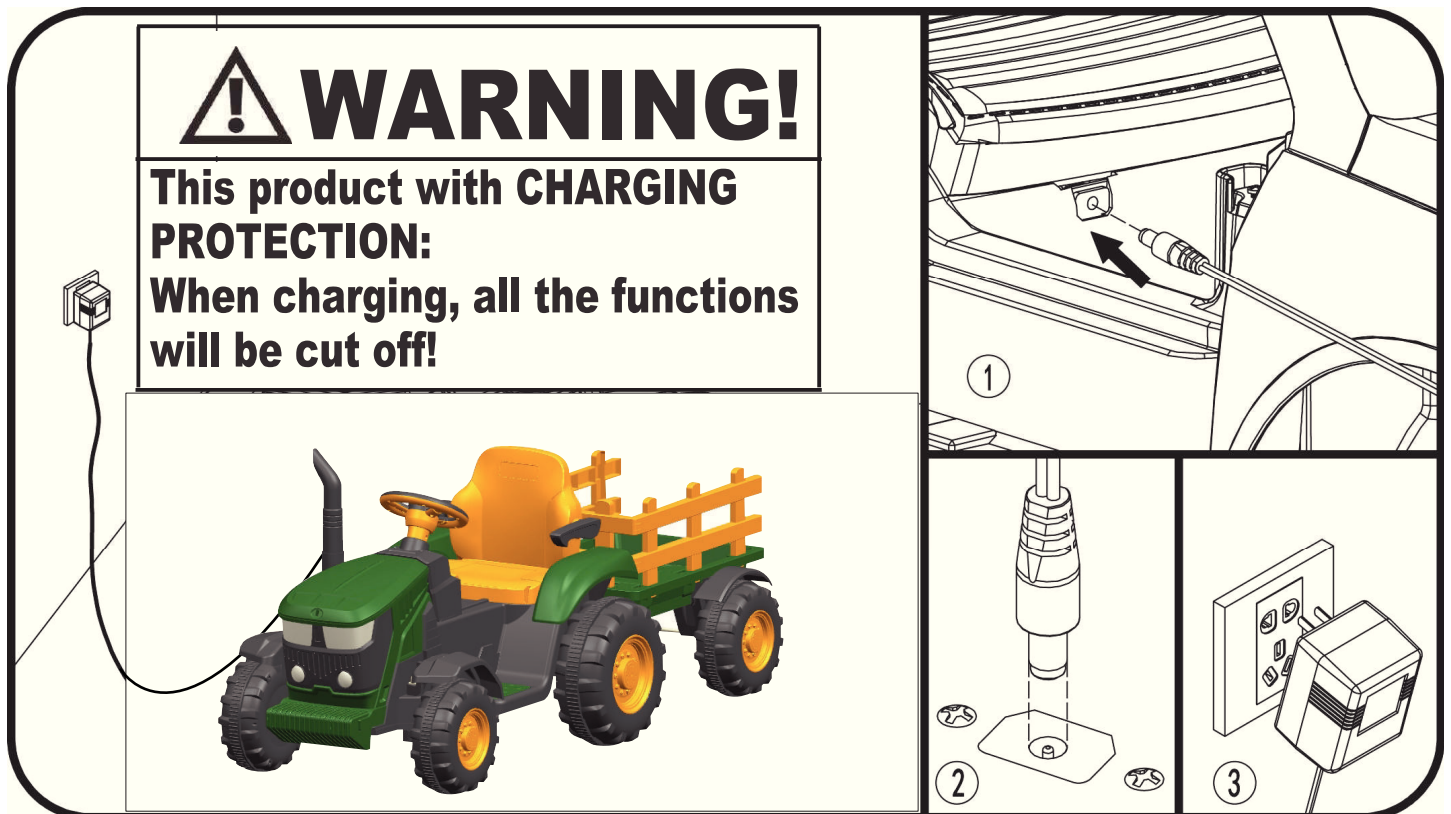

1. Find The charging input socket below the seat;
2. Plug the charger port into the input socket;
3. Plug the charger plug into a wall outlet. The battery will begin charging.

Trouble shooting Guide

■ PROBLEM: The vehicle does not run

PROBLEM CAUSE: The battery may low on power.

After each use, or once a month minimum, charge the battery for 8 hours, not exceeding 12 hours.

POSSIBLE CAUSE: Thermal fuse has tripped.

The vehicle is equipped with a self-resetting fuse. When the vehicle is overloaded or operated incorrectly; the self-resetting fuse will be cut off for 5-20seconds before becoming operational again. The self-resetting fuse is under the seat (Refer to the picture.)

DO NOT overload the vehicle,Maximum weight allowed:30kg

DO NOT tow anything behind the vehicle.

DO NOT drive up steep slopes.

DO NOT drive into fixed objects,which may cause the wheels to spin, causing the motor to overheat.

DO NOT drive in very hot weather,components may overheat.

DO NOT tamper with the electric system,Doing so may create a short circuit,causing the fuse to trip.

POSSIBLE CAUSE: Wheel nuts are loose.

If the nuts are not tight, the wheels will not engage the forward gears. Tighten the nut with the nut wrench

POSSIBLE CAUSE: Battery connector or wires are loose.

Make Sure the battery connectors are firmly plugged in to each other.

POSSIBLE CAUSE: Battery is dead.

Have you properly maintained the battery according to the directions? Is the battery old? Your battery may need to be replaced.

POSSIBLE CAUSE: Electric system is damaged.

Water may have corroded the system, or loose dirt, gravel or sand might have jammed the switch.

POSSIBLE CAUSE: Motor is damaged.

The motor needs professional repair.

■ PROBLEM: The battery will not recharge.

POSSIBLE CAUSE: Battery connector or adapter connector is loose.

Make sure the battery connector and adapter connector are firmly plugged together.

POSSIBLE CAUSE: Charger is not plugged in.

Make sure the charger is plugged into the wall outlet and the power flow to the outlet is on.

POSSIBLE CAUSE: Charger is not working.

Is the charger warm while charging? If not, the charger may be broken and may need to be replaced.

Trouble shooting Guide

■ **PROBLEM:** The vehicle does not run very long.

POSSIBLE CAUSE: Battery may be undercharged.

You may not be charging the battery long enough. After each use or once a month minimum recharge time as least 8 hours, not exceeding 12 hours.

POSSIBLE CAUSE: Battery is old.

The battery will eventually lose the ability to hold a charge. Depending on the amount of use, and varying conditions, the battery should operate for one to three years. Replace the battery with a new One.

■ **PROBLEM:** The vehicle does not run very long.

This is normal and not a cause for concern. It may also be silent when charging, which is also normal.

Maintaing Your Vehicle

- It is parents' responsibility to check main parts of the toy before using, Must regularly examine for potential hazard, such as the battery, charge, cable or cord, plug, screws are fastening enclosure of other parts and that in the event of such damage, the toy must not be until that damage had been properly removed.
- Make sure the plastic parts of the vehicle are not cracked or broken.
- Occasionally use a lightweight oil to lubricate moving parts such as wheels.
- Park the vehicle indoors or cover it with a tarp to protect it from wet weather.
- Keep the vehicle away from sources of heat, such as stoves and heaters. Plastic parts may melt.
- Recharge the battery after each use. Only an adult can handle the battery. Recharge the battery at least once a month when the vehicle Raider is not being used.
- Do not wash the vehicle with a hose. Do not wash the vehicle with soap and water. Do not drive the vehicle in rainy or snowy weather. Water will damage the motor, electric system and battery.
- Clean the vehicle with a soft, dry cloth. To restore shine to plastic parts, use a non-wax furniture polish. Do not use car wax. Do not use abrasive cleaners.
- Do not drive the vehicle in loose dirt, sand or fine gravel which could damage moving parts, motors or the electric system.
- When not using, all the electrical source should be turn off. Turn off the power switch and disconnect the battery connection.

Disposal of Battery

Disposal Of Battery

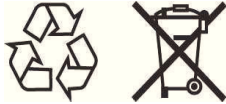

- Your sealed lead-acid battery must be recycled or disposed of in an environmentally sound manner.
- Do not dispose of your lead-acid battery in a fire. The battery may explode or leak.
- Do not dispose of a lead-acid battery in your regular, household trash. The incineration, land filling or mixing of sealed lead-acid batteries with household trash is prohibited by law.
- Return an exhausted battery to your local approved lead-acid battery recycle, such as a local seller of automotive batteries.
- Contact your local waste management officials for other information regarding the environmentally sound recycling and disposal of lead-acid batteries.
- The battery must be charged only by adult .Please charge the product before using!
- The toy should not be connected to excessive powers (more than the quantity specified herein), and it should not be operated during charging process.
- Any rechargeable battery must only be charged under adult's supervision.
- Battery charger shall regularly check the wires, plugs. casing and other parts for damage and found damage should stop using and restored.
- Please replace the battery according to the above steps and should be done by adult.
- All batteries should be inserted with the correct polarity.
- Non-rechargeable battery should not be charged, please remove any running-off battery from the toy.
- Do not use old and new batteries together, or mix different types of batteries.
- The battery charger used with the toy are to be regularly examined for damage to the cord, plug, enclosure and other parts, and in the event of such damage, they must not be used until that damage had been repaired.

